

Aluminum Electrolytic Capacitor Application

SAMWHA ELECTRIC

1. 5G

2. Automotive

3. Transportation

4. Household Appliance

5. Solar Power Inverter





6. Power Electronics

Recommended Series for Applications





New & Upgrade Series

1. 5G

- For Ultra-high Temperature, Long life, and Low Impedance

<p>PJ 135°C, 3000h Ultra High Temp.</p> 	<p>MT 105°C, 12000h Low Temp. -40°C Assurance</p> 	<p>MH 105°C, 12000h Low Imp. Long Life</p> 	<p>MG 105°C, 20000h Ultra Long Life</p> 
--	--	--	--



<p>ML 105°C, 10000h Ultra Low Imp. Long Life</p> 	<p>QY 105°C, 13000h Long Life</p> 	<p>YM 125°C 4000h SMD Type Hybrid Capacitor</p> 	<p>YB 105°C, 10000h Lead Type Hybrid Capacitor</p> 
---	---	--	---

Recommended Series for Applications

New & Upgrade Series





2. Automotive

- For Powertrain(Engine control, Transmission control, DC/DC-converter)

<p>UR</p>  <p>125°C 5000h High Temp, Low ESR</p>	<p>UN</p>  <p>125°C 2000h Extremely Low ESR</p>	<p>VQ 150°C, 1000h Ultra High Temp.</p> 	<p>YT</p>  <p>150°C 1000h Hybrid Capacitor</p>
--	---	---	--







- For Safety (Camera & radar systems, Breaking, Airbag, ABS)

<p>CG</p>  <p>105°C 2000h Extremely Low Impedance</p>	<p>MG 105°C, 20000h Ultra Long Life</p> 	<p>VP 135°C, 3000h Ultra High Temp.</p> 	<p>YC</p>  <p>105°C 10000h Hybrid Capacitor</p>
---	--	---	---



- For Exterior (LED headlight)

<p>UR</p>  <p>125°C 5000h High Temp, Low ESR</p>	<p>JL</p>  <p>105°C 10000h Long Life</p>	<p>YH</p>  <p>125°C 4000h SMD Type Hybrid Capacitor</p>	<p>YL 125°C, 4000h Lead Type Hybrid Capacitor</p> 
--	--	--	--



Recommended Series for Applications

3. Transportation

- For Large Capacitance and High Ripple Current in Stud type

EV  105°C 5000h For Inverter, Long Life	GL  85°C 20000h For Inverter, Long Life	GR  85°C 5000h For Inverter, High Ripple
---	---	--

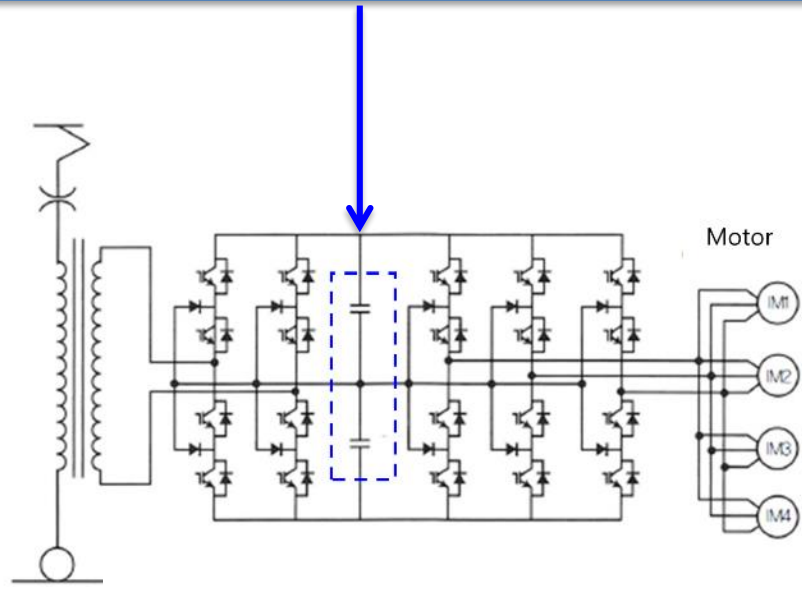



Recommended Series for Applications

New & Upgrade Series

4. Household Appliance

- For High Ripple Current, Miniaturization and Long Life

For Air conditioner Inverter

<p>AL</p>  <p>85°C 5000h High Ripple</p>	<p>AQ</p>  <p>85°C 7000h High Ripple, Long Life</p>	<p>AJ</p>  <p>105°C 5000h For Inverter, High Ripple</p>
--	---	---

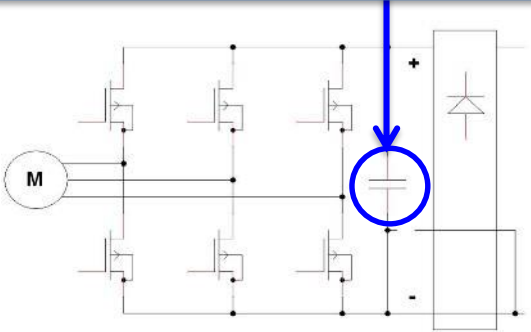

For Household

<p>RH</p>  <p>105°C 5000h High Ripple</p>	<p>JF</p>  <p>105°C 5000h High Ripple</p>	<p>JY</p>  <p>105°C 10000h Long Life</p>
---	---	--

Recommended Series for Applications

5. Solar Power Inverter

- For High Voltage, Large Capacitance and High Ripple Current

New & Upgrade Series

HY HG 105°C IM 450VV 180μF 105°C 7000h 500Vdc, Long Life	HL HL 105°C IM 450VV 180μF 105°C 5000h 500Vdc, Long Life	GL GL 85°C IM 450VV 1000μF 85°C 20000h For Inverter, Long Life	GR GR 85°C IM 450VV 410μF 85°C 5000h For Inverter, High Ripple
--	--	--	--

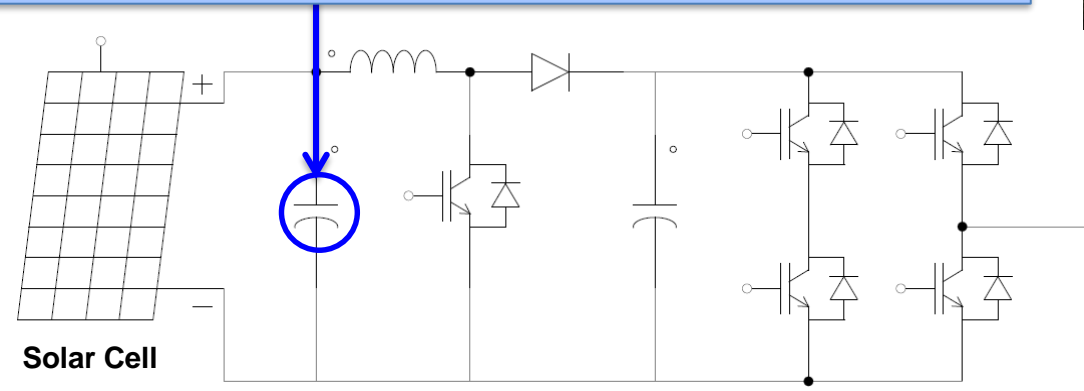

Recommended Series for Applications

6. Power Electronics

New & Upgrade Series

- For Large Capacitance, High Ripple Current and Long Life

<p>GY</p>  <p>85°C 2000h For Inverter</p>	<p>GL</p>  <p>85°C 20000h For Inverter, Long Life</p>	<p>GR</p>  <p>85°C 5000h For Inverter, High Ripple</p>	<p>KG</p>  <p>105°C 3000h High Ripple, Wide Temp</p>	<p>JY</p>  <p>105°C 10000h Long Life</p>
---	---	--	--	--

- For Power industry , Plant business, Infrastructure business segment

<p>DB</p>  <p>65°C 1500h Snap-in Type</p>	<p>DK</p>  <p>80°C 1500h Snap-in Type</p>	<p>DH</p>  <p>65°C 1500h Weldable, Threaded Type</p>	<p>DM</p>  <p>65°C 1500h Module type</p>
---	---	--	--

Samwha's Main Customers

IT

SAMSUNG	 LG	 Hansol	 DONG YANG E&P energy & power solution	 Powernet Display & Mobile Devices Xpert
 Carrier	 DAEWOO	 navien	Electrolux	RUTRONIK
ASUS	 SAGEM	Skyworth	 arçelik	PEGATRON

Automotive

	HYUNDAI MOBIS	DELPHI	OMRON	
---	----------------------	---------------	--------------	---

Industrial

		SIEMENS		Continental 
--	--	----------------	--	---

Others (medical, LED)

SAMSUNG MEDISON	DRGEM DRGEM Corporation	 KUMHO ELECTRIC	 DASS Tech	 ENERCON ENERGIE FÜR DIE WELT
------------------------	-----------------------------------	--	--	--